

KATALOG 2021

cod. IC0000PL

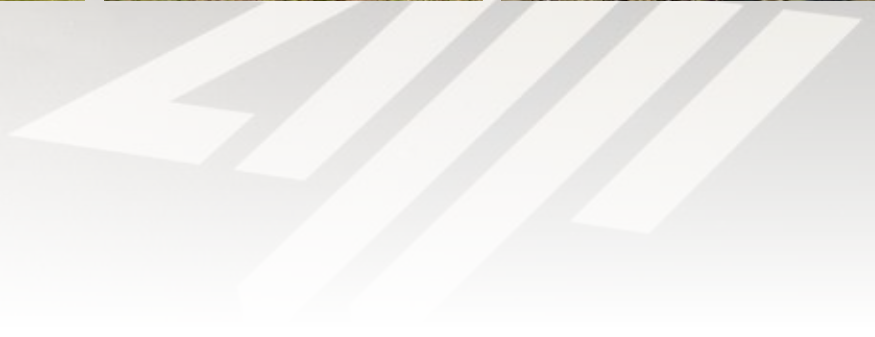

ZILLI Sp. z o.o.

Pielęgnowujemy pasję od 1952

Od 1952 roku tworzymy maszyny rolnicze używając najlepszych materiałów dostępnych na rynku i z roku na rok zyskujemy nowe doświadczenie idąc na bieżąco z postępem technologicznym, dzięki czemu nasze produkty corocznie potwierdzają się jako symbol innowacji.

Firma Zilli położona jest w otoczonej zielonymi łąkami San Quirino w pobliżu autostrady A28.

Linia produkcyjna przedsiębiorstwa oraz jej biura znajdują się w 3000 m² hali, nieopodal 4000 m² i 6000 m² pól, które używane są do testowania naszych produktów.





Firma Zilli została założona w 1952 roku przez braci Guerrino i Giuseppe Zilli, dzięki ich pasji do maszyn rolniczych oraz rolnictwa.

W historycznej siedzibie w Pordenone były produkowane rozdrabniacze, prasy oraz ładowarki paszy. Firma jest posiadaczem wielu patentów oraz licznych nagród otrzymanych w uznaniu za innowacyjność produktów które co roku są prezentowane na Międzynarodowych Targach.

W 1977 roku linia produkcyjna została przeniesiona do nowej hali w San Quirino a w 1978 rozpoczęto produkcję rozdrabniaczy. W 2018 roku Zilli Sp.z.o.o. odnawia swój wizerunek; technologia podąża w parze z doświadczeniem, utrzymując w tym samym czasie ścisłą więź z 60-letnią tradycją rzemieślniczą firmy.



ROZDRABNIACZE

ROZDRABNIACZE I KOSIARKI ZILLI są maszynami odpowiednimi do 3-punktowego przymocowania do traktora; opierają się na wałach lub kołach, które pozwalają regulować wysokość trybu pracy, kręcąc się na łatwych w utrzymaniu łożyskach. Mogą być wyposażone w młoty lub noże, zależnie od życzenia klienta. Maszyny rolnicze produkowane przez ZILLI Sp. z o.o. są zrobione z wysokiej jakości stali, zgodnie z przepisami Unii Europejskiej.



PICO Kosiarka bijakowa od 850 do 1200 mm

Maszyna półzawieszana odpowiednia do koszenia trawy w parkach, ogrodach oraz obszarach o małej wielkości, doczepiana do traktorów o niskiej mocy.

KOD													
	mm	mm	kw hp	n° n/1'	kg	n°	n°	n°	A B C				
2920.850	860	520	450	6 8	2 540	110	1	14	28	970 650 850			
2920.100	970	520	560	7 10	2 540	120	1	16	32	1080 650 850			
2920.110	1080	630	560	9 13	2 540	145	1	18	36	1190 650 850			
2920.120	1200	630	670	11 15	2 540	160	1	20	40	1300 650 850			

ERBA Kosiarka bijakowa od 1000 mm do 1600 mm











Model ERBA to mulczer półzawieszany polecany do koszenia trawy w parkach, ogrodach i winnicach. Nadaje się również do kruszenia cienkiego drewna, można go podłączyć do ciągników o mocy co najmniej 15 Hp.

KOD													
	mm	mm	kw hp	n° n/1'	kg	n°	n°	n°	A B C				
2904.100	1000	620	560	11 15	3 540	215	2	12	24	1180 910 1000			
2904.120	1200	620	760	12 16	3 540	230	2	12	24	1380 910 1000			
2904.140	1400	540 690	1040 890	14 20	3 540	250	2	16	32	1580 910 1000			
2904.160	1600	580 730	1200 1050	18 25	3 540	270	2	20	40	1780 910 1000			

EDEN Kosiarka bijakowa od 1200 mm do 1800 mm



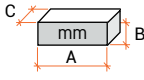





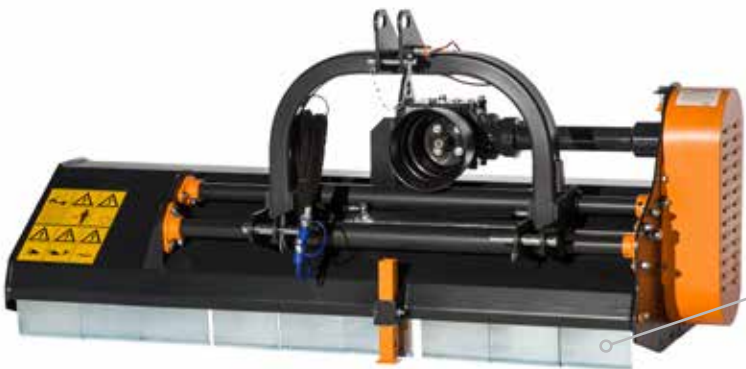

Wyposażony jest w samoczyszczący wałek tylny z wyrzutem za wałem. Ruch boczny odbywa się za pomocą cylindrycznych prowadnic, na których działają samosmarujące tuleje.

KOD													
	mm	mm	kw hp	n°	n/1'	kg	n°	n°	n°	A	B	C	
2905.120	1200	540 690	840 690	13 18	3	540	230	2	12	24	1360	940	860
2905.140	1400	540 690	1040 890	14 20	3	540	250	2	16	32	1560	940	860
2905.160	1600	540 690	1200 1050	18 25	3	540	270	2	20	40	1760	940	860
2905.180	1800	780 930	1200 1050	26 35	3	540	300	2	24	48	1960	940	860

ASSO Kosiarka bijakowa od 1400 mm do 2200 mm



Model ASSO to rozdrabniacz półzawieszany odpowiedni do koszenia trawy i rozdrabniania drewna o średnicy do 4-5 cm. Ruch boczny odbywa się za pomocą prowadnic cylindrycznych. Odpływ znajduje się z tyłu rolki nośnej.

KOD													
	mm	mm	kw hp	n°	n/1'	kg	n°	n°	n°	A	B	C	
2908.140	1400	530 960	1050 620	22 30	3	540	360	3	16	32	1580	1050	970
2908.160	1600	530 960	1250 820	26 35	3	540	410	3	20	40	1780	1050	970
2908.180	1800	530 960	1450 1020	30 40	4	540	430	3	20	40	1980	1050	970
2908.200	2000	530 960	1650 1220	36 50	4	540	460	3	24	48	2180	1050	970
2908.220	2200	530 960	1850 1420	41 55	5	540	480	3	24	48	2380	1050	970

RAMA 4 Kosiarka bijakowa mulczer od 1400 mm do 2200 mm

Rozdrabniacz model RAMA, półzawieszany, odpowiedni do rozdrabniania trawy, pędów winorośli, drewna itp. Nadaje się do użytku w winnicach, może być wyposażony w tylne zęby żniwne zwiększające rozdrobnienie materiałów.

KOD													
	mm	mm	kw	hp	n°	n/1'	kg	n°	n°	n°	A	B	C
2922.140	1400	650 950	28	40	4	540	490	4	16	32	1600	950	1100
2922.160	1600	650 950	28	40	4	540	530	4	16	32	1800	950	1100
2922.180	1800	650 950	32	45	4	540	550	4	20	40	2000	950	1100
2922.200	2000	820 1180	36	50	4	540	590	4	24	48	2200	950	1100
2922.220	2200	820 1180	44	60	4	540	650	4	24	48	2400	950	1100

RAMA 5 Kosiarka bijakowa mulczer od 2600 mm do 3000 mm



Rozdrabniacz model RAMA, półzawieszany, odpowiedni do rozdrabniania trawy, pędów winorośli, drewna itp. Nadaje się do użytku w winnicach, może być wyposażony w tylne zęby żniwne zwiększające rozdrobnienie materiałów.

KOD													
	mm	mm	kw	hp	n°	n/1'	kg	n°	n°	n°	A	B	C
2922.260	2600	1220 1470	60	80	5	540	740	5	24	48	2800	950	1100
2922.280	2750	1220 1470	68	90	5	540	790	5	24	48	2950	950	1100
2922.300	3000	1220 1470	75	100	5	540	850	5	28	56	3200	950	1100

RIVA-E 1 Rozdrabniacz tylny boczny

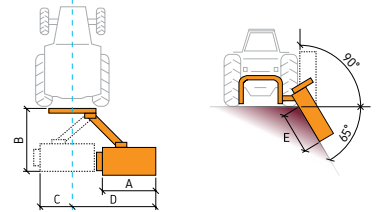

Model RIVA-E 1 to lekka kosiarka bijakowa boczna, odpowiednia do małych ciągników, przeznaczona do rozdrabniania trawy w ogrodach i parkach.



KOD															
	mm	mm	kw	hp	kg	n°	n/1'	kg	n°	n°	n°	B	C	D	E
2910.120	1200	1550	38	35	800	2	540	280	1	16	-	1700	630	2550	1100

RIVA 2 / RIVA-E 2 Rozdrabniacz tylny boczny od 1200 mm do 1800 mm



Riva 2 to półprofesjonalny rozdrabniacz boczny odpowiedni zarówno do rozdrabniania trawy w parkach, jak i do czyszczenia rowów i żywopłotów. Dostępny w następujących konfiguracjach: z wewnętrznym lub zewnętrznym multiplikatorem do korpusu.

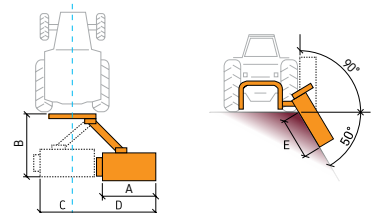

RIVA 2 - Z wewnętrznym mnożnikiem

KOD															
	mm	mm	kw	hp	kg	n°	n/1'	kg	n°	n°	n°	B	C	D	E
2914.120	1200	1400	35	48	1200	3	540	380	2	12	24	1680	600	2130	790
2914.140	1400	1600	35	48	1200	3	540	400	2	16	32	1680	600	2330	990
2914.160	1600	1800	35	48	1200	3	540	420	2	20	40	1680	600	2530	1190
2914.180	1800	2000	40	55	1500	3	540	450	2	24	48	1680	600	2730	1390

RIVA-E 2 - Z zewnętrznym mnożnikiem

KOD															
	mm	mm	kw	hp	kg	n°	n/1'	kg	n°	n°	n°	B	C	D	E
2915.120	1200	1630	35	48	1300	3	540	400	2	12	24	1680	580	2390	1050
2915.140	1400	1830	35	48	1400	3	540	420	2	16	32	1680	580	2590	1250
2915.160	1600	2030	35	48	1500	3	540	430	2	20	40	1680	580	2790	1450
2915.180	1800	2230	40	55	1600	3	540	470	2	24	48	1680	580	2990	1650





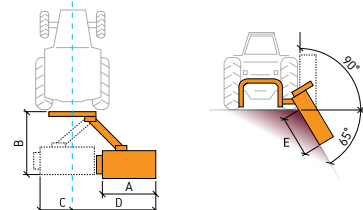



RIVA 3 / RIVA-E 3 Rozdrabniacz tylny boczny od 1400 mm do 2200 mm

RIVA 3 to profesjonalny mulcer boczny, odpowiedni do czyszczenia nasypów drogowych, krawędzi, rowów i żywopłotów. Wysyp wytwarzany za walcem, który jest samoczyszczący. Obsługa na samosmarujących się tulejach metalowych.

RIVA 3 - Z wewnętrznym mnożnikiem

KOD	 mm	 mm		kw	hp	kg	 n°	 n/1'	 kg	 n°	 n°	 n°	B	C	D	E
2911.140	1400	1580		55	75	2100	3	540	530	3	16	32	2000	900	2350	1300
2911.160	1600	1780		60	80	2200	3	540	580	3	20	40	2000	900	2350	1500
2911.180	1800	1980		63	85	2300	4	540	610	3	20	40	2000	900	2350	1700
2911.200	2000	2180		66	90	2400	4	540	650	3	24	48	2000	900	2350	1900
2911.220	2200	2380		69	95	2500	5	540	700	3	24	48	2000	900	2350	2100

RIVA-E 3 - Z zewnętrznym mnożnikiem

KOD	 mm	 mm		kw	hp	kg	 n°	 n/1'	 kg	 n°	 n°	 n°	B	C	D	E
2912.140	1400	1890		55	75	2300	3	540	550	3	16	32	2000	560	2650	1600
2912.160	1600	2090		60	80	2400	3	540	600	3	20	40	2000	560	2850	1800
2912.180	1800	2290		63	85	2500	4	540	630	3	20	40	2000	560	3050	2000
2912.200	2000	2490		66	90	2600	4	540	670	3	24	48	2000	560	3250	2200
2912.220	2200	2690		69	95	2700	5	540	690	3	24	48	2000	560	3450	2400

RIVA-E 4 Rozdrabniacz tylny boczny od 1400 mm do 2200 mm



NEW

RIVA-E 4 to profesjonalny rozdrabniacz boczny, odpowiedni do czyszczenia nasypów drogowych, krawędzi, rowów i żywopłotów. Wysyp wytwarzany za walcem, który jest samoczyszczący. Obsługa na samosmarujących się tulejach metalowych.

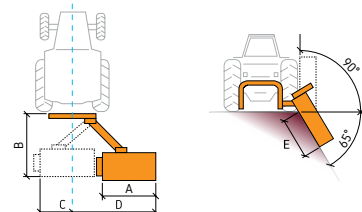

KOD															
	mm	mm	kw	hp	kg	n°	n/1'	kg	n°	n°	n°	B	C	D	E
2926.160	1600	2120	60	82	2500	4	540	970	4	16	2270	2270	340	2750	1370
2926.180	1800	2320	60	82	3000	4	540	990	4	20	2270	2270	340	2950	1570
2926.200	2000	2520	66	90	3400	4	540	1030	4	24	2270	2270	340	3150	1770
2926.220	2200	2720	74	100	3900	4	540	1090	4	24	2270	2270	340	3350	1970
2926.260	2600	3120	81	110	4400	5	540	1180	5	24	2270	2270	340	3750	2370

TWIN 2 Rozdrabniacz bijakowy dwustronny od 1200 mm do 1800 mm



Rozdrabniacz półzawieszany bijakowy dwustronny, do użytku z mobilnymi narzędziami odpowiednimi do kruszenia pędów i drewna o średnicy do 5 cm. Trzypunktowy, podwójny uchwyt z przsuwem bocznym na tulejach samosmarujących.

KOD													
	mm	mm	kw	hp	n°	n/1'	kg	n°	n°	n°	A	B	C
2906.120	1200	615 870	15	20	3	540	270	2	12	24	1360	1050	880
2906.140	1400	615 870	19	25	3	540	300	2	16	32	1560	1050	880
2906.160	1600	615 870	22	30	3	540	310	2	20	40	1760	1050	880
2906.180	1800	615 870	29	40	3	540	350	2	24	48	1960	1050	880

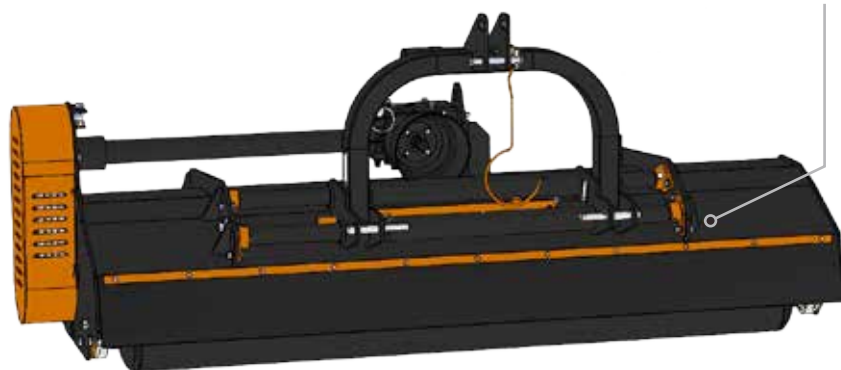
TWIN 3 Rozdrabniacz bijakowy dwustronny od 1800 mm do 2200 mm

Rozdrabniacz półzawieszany, do użytku z mobilnymi narzędziami odpowiednimi do kruszenia pędów i drewna o średnicy do 5 cm. Podwójny TUZ z translacją na tulejach samosmarujących

KOD													
	mm	mm	kw hp	n°	n/1'	kg	n°	n°	n°	A	B	C	
2916.180	1800	760 900	1180 1040	30 40	4	540	400	3	20	40	1940	1200	1000
2916.200	2000	860 1000	1280 1140	36 50	4	540	480	3	24	48	2140	1200	1000
2916.220	2200	960 1100	1380 1240	44 60	4	540	460	3	24	48	2340	1200	1000

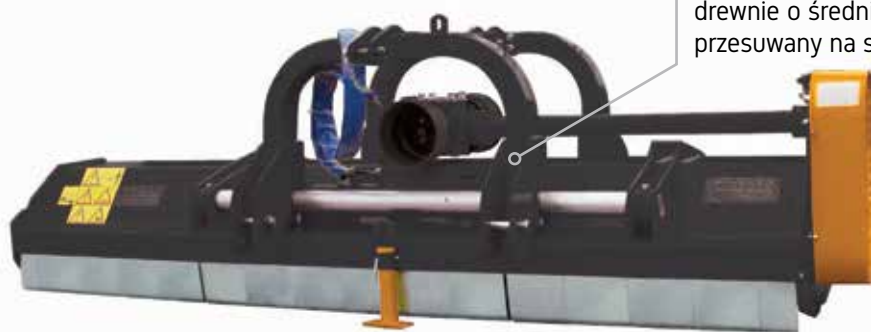
TWIN 4 Rozdrabniacz bijakowy dwustronny od 1600 mm do 2200 mm











Rozdrabniacz półzawieszany, do użytku z mobilnymi narzędziami odpowiednimi do rozdrabniania pędów, jeżyn, krzewów i obszarów nieuprawianych, do stosowania na drewnie o średnicy do 8 cm. Podwójny trzypunktowy zaczep przesuwany na samosmarujących się prowadnicach.

KOD													
	mm	mm	kw hp	n°	n/1'	kg	n°	n°	n°	A	B	C	
2923.160	1600	650 950	1150 850	28 40	4	540	530	4	16	32	1800	950	1120
2923.180	1800	650 950	1350 1050	32 45	4	540	550	4	20	40	2000	950	1120
2923.200	2000	820 1180	1380 1020	36 50	4	540	590	4	24	48	2200	950	1120
2923.220	2200	820 1180	1580 1220	44 60	4	540	650	4	24	48	2400	950	1120

TWIN-SO 4 Rozdrabniacz bijakowy dwustronny offset od 1600 mm do 2000 mm





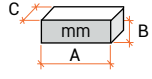



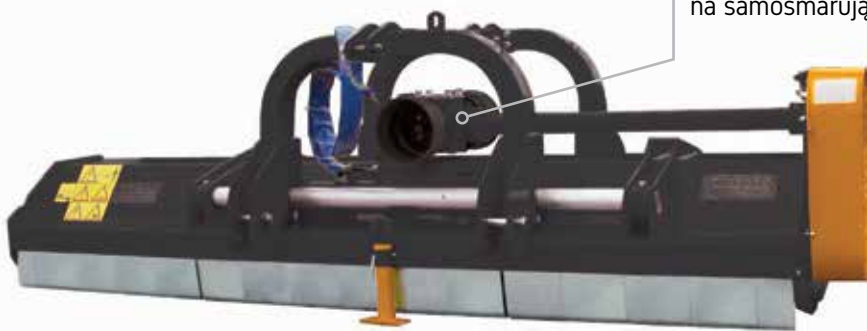

Rozdrabniacz półzawieszany, do użytku z mobilnymi narzędziami odpowiednimi do rozdrabniania gałęzi i drewna o średnicy do 6 cm. Napęd pasowy po prawej stronie, przesunięcie na lewą stronę zwiększone o 240mm, z zachowaniem skrajni.

KOD													
	mm	mm	kw hp	n°	n/1'	kg	n°	n°	n°	A	B	C	
2924.160	1600	960 1390	870 500	28 40	4	540	550	4	16	32	1830	950	1120
2924.180	1800	1160 1590	870 500	32 45	4	540	570	4	20	40	2030	950	1120
2924.200	2000	1360 1790	870 500	36 50	4	540	610	4	24	48	2230	950	1120

TWIN 5 Rozdrabniacz bijakowy dwustronny od 2600 mm do 3000 mm

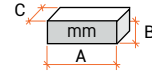

Rozdrabniacz półzawieszany, do użytku z mobilnymi narzędziami odpowiednimi do rozdrabniania gałęzi i drewna o średnicy do 8 cm. Podwójny trzypunktowy zaczep przesuwany na samosmarujących się prowadnicach.

KOD													
	mm	mm	kw hp	n°	n/1'	kg	n°	n°	n°	A	B	C	
2923.260	2600	1220 1470	1580 1330	60 80	5	540	740	5	24	48	2800	950	1120
2923.280	2750	1220 1470	1780 1530	68 90	5	540	790	5	24	48	3000	950	1120
2923.300	3000	1220 1470	1980 1730	75 100	5	540	920	5	28	56	3200	950	1120

TWIN-5 PRO Profesjonalny rozdrabniacz bijakowy dwustronny od 2600 mm do 3000 mm

Profesjonalny rozdrabniacz, do użytku z mobilnymi narzędziami odpowiednimi do cięcia trawy, łądyg, krzewów oraz drewna do Ø 9 cm. Może być również stosowany wraz z ciągnikami z napędem wstecznym. Solidna konstrukcja pozwala na użytkowanie w trudnych warunkach, takich jak odłogi.



KOD												
	mm	mm	kw hp	n° n/1'	kg	n°	n°	n°	A	B	C	
2913.260	2600	1220 1470	1580 1330	113 150	5 1000	1170	5	24	48	2800	950	1120
2913.280	2800	1220 1470	1780 1530	113 150	5 1000	1210	5	24	48	3000	950	1120
2913.300	3000	1220 1470	1980 1730	113 150	5 1000	1320	5	28	56	3200	950	1120

DECA Kosiarka bijakowa ciężka od 2300 do 3000 mm





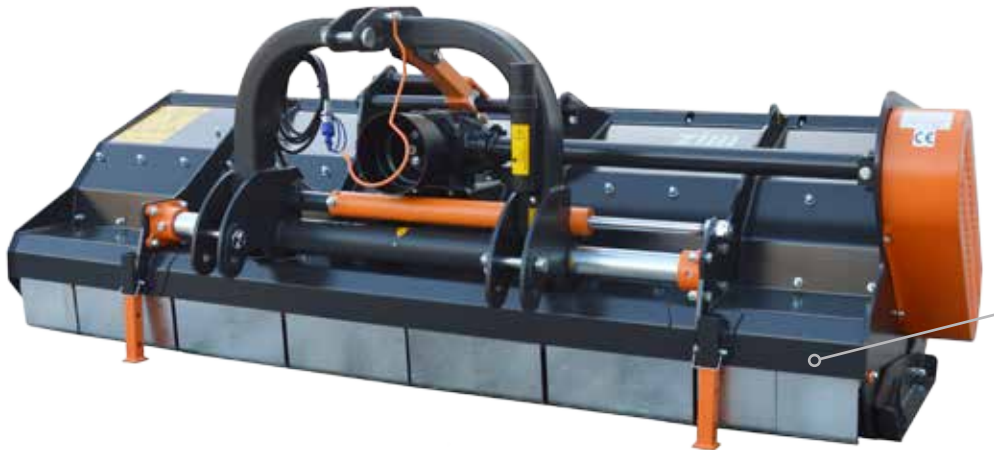

Kosiarka półzawieszana, solidna i kompaktowa idealna do koszenia trawy, drewna i łądyg kukurydzy, nawet w trudnych i ciężkich warunkach pracy.

KOD												
	mm	mm	kw hp	n° n/1'	kg	n°	n°	n°	A	B	C	
2903.230	2300	740 1330	1770 1180	57 75	5 540	870	6	24	48	2510	1095	1385
2903.260	2600	880 1480	1930 1330	60 80	5 540	980	6	28	56	2810	1095	1385
2903.280	2750	960 1560	2000 1400	68 90	5 540	1080	6	28	56	2960	1095	1385
2903.300	3000	1080 1680	2130 1530	75 100	5 540	1200	6	32	64	3210	1095	1385

DAGA Rozdrabniacz bijakowy od 1600 mm do 3000 mm



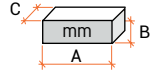









Maszyna półzawieszana ze stałą ramą, polecana do mulczowania łodyg kukurydzy, liści buraków, słomy i innych. Otwierana kłapa tylna (tylko do przeglądu), ruchomy 3-punktowy zaczep.

KOD												
	mm	kw hp	n°	n/1'	kg	n°	n°	n°	A	B	C	
2901.200	2000	40 55	4	540	680	4	20	40	2240	960	1600	
2901.230	2300	48 65	4	540	770	5	28	56	2540	960	1600	
2901.260	2600	50 70	5	540	830	5	28	56	2840	960	1600	
2901.280	2750	60 80	5	540	900	5	28	56	3000	960	1600	
2901.300	3000	75 100	6	540	1100	6	32	64	3200	960	1600	

DAGA-V Rozdrabniacz składany od 4800 mm do 6000 mm

Maszyna półzawieszana z hydraulicznie składaną ramą, polecana do cięcia łodyg kukurydzy, liści buraków, słomy i innych. Bardzo wytrzymała rama, utrzymuje formę podczas transportu drogowego.

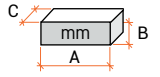

KOD														
	mm	mm	mm	kw hp	n°	n/1'	kg	n°	n°	n°	A	B	C	
2950.480	4750	2390	2400 — 2400	110 150	10	1000	2400	5	56	112	5220	1570	1600	
2950.600	5800	2400	2400 — 2900	145 200	10	1000	2900	6	72	144	6220	1570	1600	

IDRA Kosiarka hydrauliczna od 1200 mm do 1600 mm

IDRA to hydraulicznie sterowana kosiarka, nadająca się do maszyn roboczych. Umożliwia cięcie trawy i kruszenie cienkiego drewna.

KOD									
	mm	Lt bar	n/1'	kg	n°	n°	A	B	C
2907.120	1200	36 180	2050	240	2	20	1330	710	950
2907.140	1400	36 180	2050	270	2	24	1530	710	950
2907.160	1600	36 180	2050	300	2	28	1730	710	950

IDRA-M Kosiarka bijakowa z napędem wałowym od 1200 mm do 1600 mm

NEW

IDRA-M to kosiarka z napędem wałowym do małych ciągników. Umożliwia cięcie trawy i kruszenie cienkiego drewna.

KOD									
	mm	kw hp	PTO	kg	n°	n°	A	B	C
2917.120	1200	26 35	2050	255	2	20	1330	710	950
2917.140	1400	28 38	2050	285	2	24	1530	710	950
2917.160	1600	36 40	2050	315	2	28	1730	710	950

FILO Kosiarka z obrotowymi ostrzami



Kosiarka o zmiennej szerokości, zaprojektowana z myślą o dostosowaniu do wszystkich rzędów winnic i ogólnie sadów. Solidna konstrukcja została zaprojektowana tak, aby mogła pracować w warunkach rozłączonych międzyrzędzi. Niska rama umożliwia maszynie przejazd pod roślinnością bez powodowania uszkodzeń.

KOD												
	mm	mm	kw	hp	n°	n/1'	kg	n°	A (min.)	A (max.)	B	C
2812.140	1400	1900	44	60	-	540	780	4	1520	2000	970	1900
2812.170	1700	2300	55	75	-	540	860	4	1790	2390	970	2050







KULTYWATORY





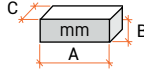

SUSTE Kultywator wibracyjny

Kultywator wibracyjny SUSTE ze stabilnym podwoziem odpowiednim do pracy na ciężkim podłożu, jest idealnym rozwiązaniem do przygotowania łoża siewnego. Jest wyposażony w elastyczne sprężyny ułożone w 4 rzędach, przednią listwę poziomującą i podwójny tylny wał do okruszania.

Podwozie stałe

KOD	 mm	 mm		 kg	 n°	
	mm	mm	kw hp	kg	n°	A B C
4200.222	2220	2220	60 80	520	21	2500 1100 2400

Podwozie elastyczne

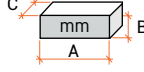
KOD	 mm	 mm		 kg	 n°	
	mm	mm	kw hp	kg	n°	A B C
4201.410	4080	4080	90 120	1280	39	4430 1950 2400
4201.600	6000	6000	120 160	1700	55	6150 1910 2400

COLTA Kultywator dłutowy



Kultywator dłutowy COLTA, nowoczesnej koncepcji, składa się z solidnej konstrukcji, szczególnie odpowiedniej do twardych i kamienistych gleb. Dzięki swojej precyzji pracy i niezawodności jest idealnym rozwiązaniem do przygotowania łoża siewnego.

Wersja podstawowa

KOD									
	mm	mm	kw	hp	kg	n°	A	B	C
41013515	2500	3650	112	150	1050	15	2530	-	1680
41014017	2500	4270	120	150	1140	17	2530	-	1680
41014519	2500	4660	135	160	1200	19	2530	-	1680
41015021	2500	5300	150	180	1300	21	2530	-	1680

Wersja z wałem

KOD									
	mm	mm	kw	hp	kg	n°	A	B	C
41023515	2500	3650	112	150	1390	15	2530	-	2300
41024017	2500	4270	120	150	1540	17	2530	-	2300
41024519	2500	4660	135	160	1640	19	2530	-	2300
41025021	2500	5300	150	180	1800	21	2530	-	2300

Wersja z wałem i listwą poziomującą

KOD									
	mm	mm	kw	hp	kg	n°	A	B	C
41033515	2500	3650	112	150	1750	15	2530	-	2540
41034017	2500	4270	120	150	1900	17	2530	-	2540
41034519	2500	4660	135	160	1980	19	2530	-	2540
41035021	2500	5300	150	180	2140	21	2530	-	2540

SIEWNIKI



SEED-ON Siewnik ręczny jednorzędowy

Ręczny siewnik jednoziarnisty do ogródków warzywnych lub otwartych pól, bardzo łatwy w obsłudze. Talerz umieszczony na dnie zbiornika aktywuje się podczas podnoszenia, a następnie opuszczania siewnika za pomocą jego uchwytu.



KOD						
	n°	kg	L	A	B	C
22500001	1	1,9	0,8	230	860	150

ZFS Siewnik mechaniczny jednorzędowy

ZFS to jednorzędowy siewnik mechaniczny wyposażony w mechaniczny rozdzielacz, który może przenosić nasiona o różnych rozmiarach i umieszczać je w różnych odległościach w zależności od potrzeb. Przełożenie rozdzielacza nasion odbywa się bezpośrednio za pomocą podwójnej rotującej tarczy, w którą wyposażony jest element. Każdy element może być również wyposażony w zbiornik do dystrybucji nawozu granulowanego. Może być stosowany do traktora kroczącego lub motyki silnikowej z jednym lub dwoma rzędami z odpowiednim mocowaniem.









KOD						
	n°	kg	nasiona rozsiwacz	A	B	C
22050001	1	15	8 -	490	710	350
22060001	1	20	8 11	630	710	350

ZFM Siewnik jednonasienny wielorzędowy







ZFM to mechaniczny siewnik dystrybucyjny odpowiedni do małych ciągników, dostępna w różnych modelach, od 2 do 6 rzędów. Odpowiedni do nasion o różnych rozmiarach, może umieszczać je w różnych odległościach w zależności od zastosowanej tarczy wysiewającej. Przełożenie dystrybutora nasion odbywa się bezpośrednio za pomocą podwójnej tarczy bruzdującej, w którą wyposażony jest element.

Wersja podstawowa

KOD											
	n°	cm	kw	hp	podstawowa rozsiewacz	nasiona rozsiewacz	A	B	C		
2207.752	2	40-75	22	30	130	-	2x8	-	1200	1170	1500
2207.753	3	40-75	30	40	200	-	3x8	-	2200	1170	1500
2207.754	4	40-75	45	60	290	-	4x8	-	2420	1170	1500
2207.756	6	40-75	60	80	380	-	6x8	-	4000	1170	1500

Wersja z rozsiewaczem nawozu ze stali nierdzewnej

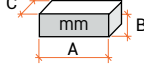
KOD											
	n°	cm	kw	hp	podstawowa rozsiewacz	nasiona rozsiewacz	A	B	C		
2208.752	2	40-75	22	30	130	200	2x8	200	1200	1170	1500
2208.753	3	40-75	30	40	200	270	3x8	380	2200	1170	1500
2208.754	4	40-75	45	60	290	360	4x8	380	2420	1170	1500
2208.756	6	40-75	60	80	380	460	6x8	480	4000	1170	1500

CHWASTOWNIKI







FLEXA-F Chwastownik ze stałą ramą





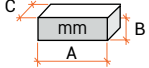

Chwastownik ze stałą ramą dostępny w wersjach od 3 do 12 rzędów z odchwaszczającymi elementami roboczymi wyposażonymi w od 3 do 5 zębów w zależności od odległości między rzędami. Wersje z rozsiewaczem nawozów są wyposażone w pojedynczy zbiornik ze stali nierdzewnej o pojemności 700, 1000 lub 2000 litrów.

Wersja podstawowa

KOD								
	n°	cm	hp	kg	L	A	B	C
3102.753	3	70-75	50	580	-	2750	1300	1800
3102.754	4	70-75	55	650	-	3500	1300	1800
3102.456	6	45-50	55	800	-	3400	1300	1800
3102.756	6	70-75	65	950	-	5000	1300	1800
3102.458	8	45-50	65	1000	-	4800	1300	1800
3102.45C	12	45-50	90	1200	-	6300	1300	1800
3102.758	8	70-75	90	1100	-	6500	1300	1800
3102.75C	12	70-75	100	1300	-	9000	1300	1800

Wersja z wolumetrycznym rozsiewaczem nawozu

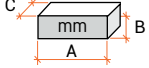



KOD								
	n°	cm	hp	kg	L	A	B	C
3104.754	4	70-75	70	900	700	3500	1800	1800
3104.456	6	45-50	70	1050	700	3400	1800	1800
3104.756	6	70-75	75	1270	1000	5000	1800	1800
3104.458	8	45-50	75	1250	1000	4800	1800	1800
3104.45C	12	45-50	100	1720	2000	6300	1800	1800
3104.758	8	70-75	100	1600	2000	6500	1800	1800
3104.75C	12	70-75	100	1980	2000	9000	1800	1800

FLEXA-M Chwastownik z hydraulicznie składaną ramą





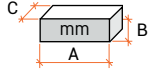

Chwastownik z hydraulicznie składaną ramą z odchwaszczającymi elementami roboczymi wyposażonymi w od 3 do 5 zębów w zależności od rozstawu międzyrzędowego. Wersje z rozsiewaczem nawozów są wyposażone w pojedynczy zbiornik ze stali nierdzewnej o pojemności 700 l. Zewnętrzne elementy odchwaszczające są zamykane od tyłu bezpośrednio za mechanizmu sterowania hydraulicznego ciągnika.

Wersja podstawowa

KOD									
	n°	cm	kw	hp	kg	L	A	B	C
3202.754	4	70-75	45	60	630	-	3480	1450	1800
3202.456	6	45-50	45	60	800	-	3480	1450	1800

Wersja z wolumetrycznym rozsiewaczem nawozu

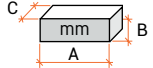



KOD									
	n°	cm	kw	hp	kg	L	A	B	C
3204.754	4	70-75	60	80	1000	700	3480	1650	1800
3204.456	6	45-50	60	80	1100	700	3480	1650	1800

FLEXA-V Pionowy chwastownik składany





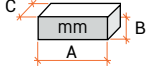

Chwastownik z pionowo składaną ramą z odchwaszczającymi elementami roboczymi, wyposażonymi w od 3 do 5 zębów w zależności od rozstawu międzyrzędowego. Wersje z rozsiewaczem nawozów są wyposażone w pojedynczy zbiornik ze stali nierdzewnej o pojemności 1000 l.

Wersja podstawowa

KOD									
	n°	cm	kw	hp	kg	L	A	B	C
3302.756	6	70-75	55	75	1000	-	5150	1400	1820
3302.458	8	45-50	55	75	1220	-	5150	1400	1820
3302.758	8	70-75	60	80	1250	-	6150	1400	1820
3302.45C	12	45-50	66	90	1510	-	6150	1400	1820

Wersja z wolumetrycznym rozsiewaczem nawozu

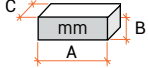
KOD									
	n°	cm	kw	hp	kg	L	A	B	C
3304.756	6	70-75	60	80	1310	1000	5150	1800	2330
3304.458	8	45-50	60	80	1550	1000	5150	1800	2330
3304.758	8	70-75	66	90	1580	1000	6150	1800	2330

ROZSIEWACZE NAWOZÓW



FERTICROP Rozsiewacz nawozu miejscowy



Rozsiewacz nawozów do miejscowej dystrybucji produktów granulowanych. Wyposażony w stałą ramę, zbiornik ze stali nierdzewnej o różnej pojemności i dostępny w 4, 6, 8 rzędach. W zależności od wydajności, szerokości transportowe wahają się od 2,00 do 2,48 m.





KOD									
	mm	n°	kw	hp	kg	L	A	B	C
1600.204	2010	4	30	40	102	360	2010	1100	650
1600.206	2010	6	30	40	102	360	2010	1100	650
1600.234	2300	4	53	70	215	800	2300	1550	950
1600.256	2480	6	60	80	235	1000	2480	1550	950
1600.258	2500	8	60	80	380	1000	2500	1750	1050

FERTIVITIS Rozsiewacz nawozu



FERTIVITIS to rozsiewacz nawozów, który umożliwia wprowadzenie produktu do gleby między rzędami winnic lub sadów. FERTIVITIS posiada stałą ramę i zbiornik ze stali nierdzewnej.

Redlice nożowe wyposażone są w zębate wałki do pomiaru głębokości. Dostępny w wersji 1 lub 2 rzędowej. Roboczy odstęp między rzędami dostępny w modelach dwurzędowych wynosi 1,4 lub 2,00 m.

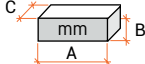
KOD									
	mm	n°	kw	hp	kg	L	A	B	C
1700.101	1400	1	22	25	230	240	1600	1400	760
1700.102	1400	2	30	40	260	240	1600	1400	760
1700.162	2000	2	38	50	292	360	2200	1400	760
1700.182	2200	2	44	60	310	360	2200	1400	760





MICROLINE Dozownik wolumetryczny

NEW



MICROLINE to dozownik wolumetryczny do miejscowej dystrybucji produktów mikrogranulkowych.

Bęben z elastycznymi komórkami umożliwia dystrybucję, natomiast regulacja odbywa się za pomocą gilotyny sterowanej obrotowym pierścieniem. MICROLINE można łatwo dostosować do każdej maszyny rolniczej i można ją wyposażać w napęd elektryczny.

KOD						
	n°	kg	L	A	B	C
13201012	1	-	12	395	385	180
13202025	2	-	25	395	385	360
13204120	4	-	120	395	385	1400

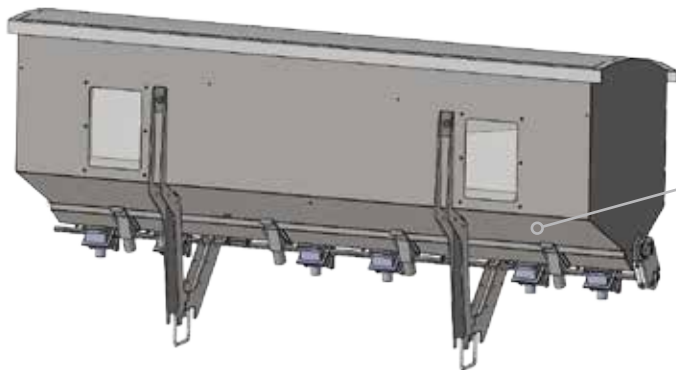

FERTILINE Rozsiewacz nawozu

NEW



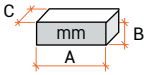

Rozsiewacz nawozu granulowanego z mechanicznym rozdzielaczem wolumetrycznym i zbiornikiem ze stali nierdzewnej. Dystrybucja może być regulowana za pomocą gilotyny lub elektronicznej lub hydraulicznej zmiany obrotów dystrybutora.

Z regulacją

KOD	 n°	 kg	 L			
				A	B	C
11100704	4	103	700	1503	775	950
11100706	6	105	700	1503	775	950
11101004	4	131	1000	2203	775	950
11101006	6	133	1000	2203	775	950
11101008	8	135	1000	2203	775	950
11101406	6	169	1400	2883	775	950
11101408	8	198	1400	2883	775	950
11101412	12	200	1400	2883	775	950

Bez regulacji

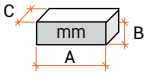
KOD	 n°	 kg	 L			
				A	B	C
11200704	4	108	700	1503	775	950
11200706	6	110	700	1503	775	950
11201004	4	136	1000	2203	775	950
11201006	6	139	1000	2203	775	950
11201008	8	140	1000	2203	775	950
11201406	6	201	1400	2883	775	950
11201408	8	203	1400	2883	775	950
11201412	12	205	1400	2883	775	950

ZILLI Srl
Via dei Templari 4, 33080 San Quirino
(Pordenone) ITALY
Tel. +39 043491053 | Fax +39 0434 91414
www.zillisrl.it | e-mail: info@zillisrl.it
CCIAA Pn 103342 | Cod.Fisc. e P.IVA
01772800932
cod. IC0000IT

